

特別提醒:

1. 圖片尺寸與實物可能略有異差，本公司保留對產品外觀及配件修改的權利，如有變更恕不另通知；
2. 由于印刷等關係，產品與圖片的顏色可能有部分異差，以產品實樣為準；
3. 有關工程項目數據請與本公司聯系。

Leah

建興貿易（香港）有限公司

地址Add: 新界葵涌大連排道162-170號金龍工業中心第二期24樓F室
電話Tel: 0852 3580 7698

廣東省栢和貿易有限公司

地址Add: 廣東省江門市萬達廣場B座33樓04室
展廳地址Add: 廣東省江門市濱江大道奧園（外灘）公館14樓
電話Tel: 0750-3092278
廠址Add: 廣東省江門市水口鎮新市北路281號
電話Tel: 0750-2720109
網址: www.kinhang789.com

Construction Trading(Hong Kong) Limited

Add: Kwai chung, New Territories, dallan road, jinlong industrial centre,
162-170 second phase of the 24th floor F room
Tel: 0852 3580 7698

Guangdong Pak and Hall co. LTD.

Add: Room 04, 33 / 1, block B, wanda plaza, jiangmen, guangdong province
Exhibition Add: No. 14 public house of oryuan (bund), binjiang avenue, jiangmen city, guangdong province
Tel: 0750-3092278
Factory Add: No. 281, xinshibei road, shuikou town, jiangmen city, guangdong province
Tel: 0750-2720109
Http://www.kinhang789.com

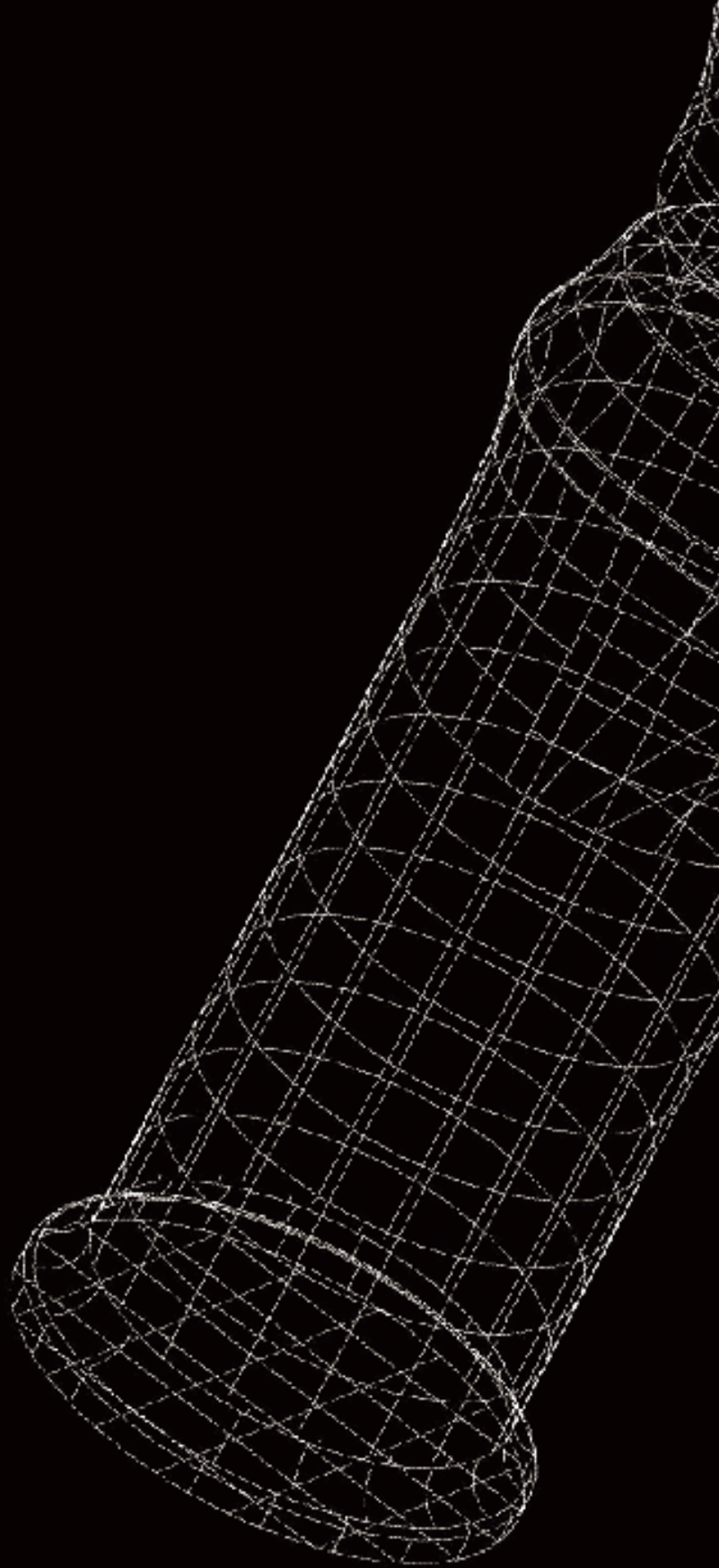

Leah



Leah



2018

CONNECTORS FOR LIFE

Leah



LEAH: 走向行業前列的制造商

LEAH 是香港品牌，致力為國內外客戶提供安全和優質的水龍頭產品，解決水龍頭含鉛超標對食用水二次污染問題。

世界衛生組織已將鉛確定為引起重大公共衛生關注的十種化學品之一，並指鉛是一種累積性毒物，影響身體多個系統，特別對幼童有危害。鉛可以透過食物、呼吸或皮膚表面吸收而進入人體，然而鉛接觸可以預防。

本公司水龍頭產品之主體原材料均採用含鉛量小於 0.1% 的銅（俗稱無鉛銅）所制成，取得香港水務署的認證，而且完全符合美國無鉛法案規定的供水設備含鉛量不得超過 0.25% 之要求。

LEAH：宗旨

公司秉承「善為至寶，心作良田」的宗旨，提供安全和優質水龍頭產品，迎合全球注重健康價值之客戶需求。

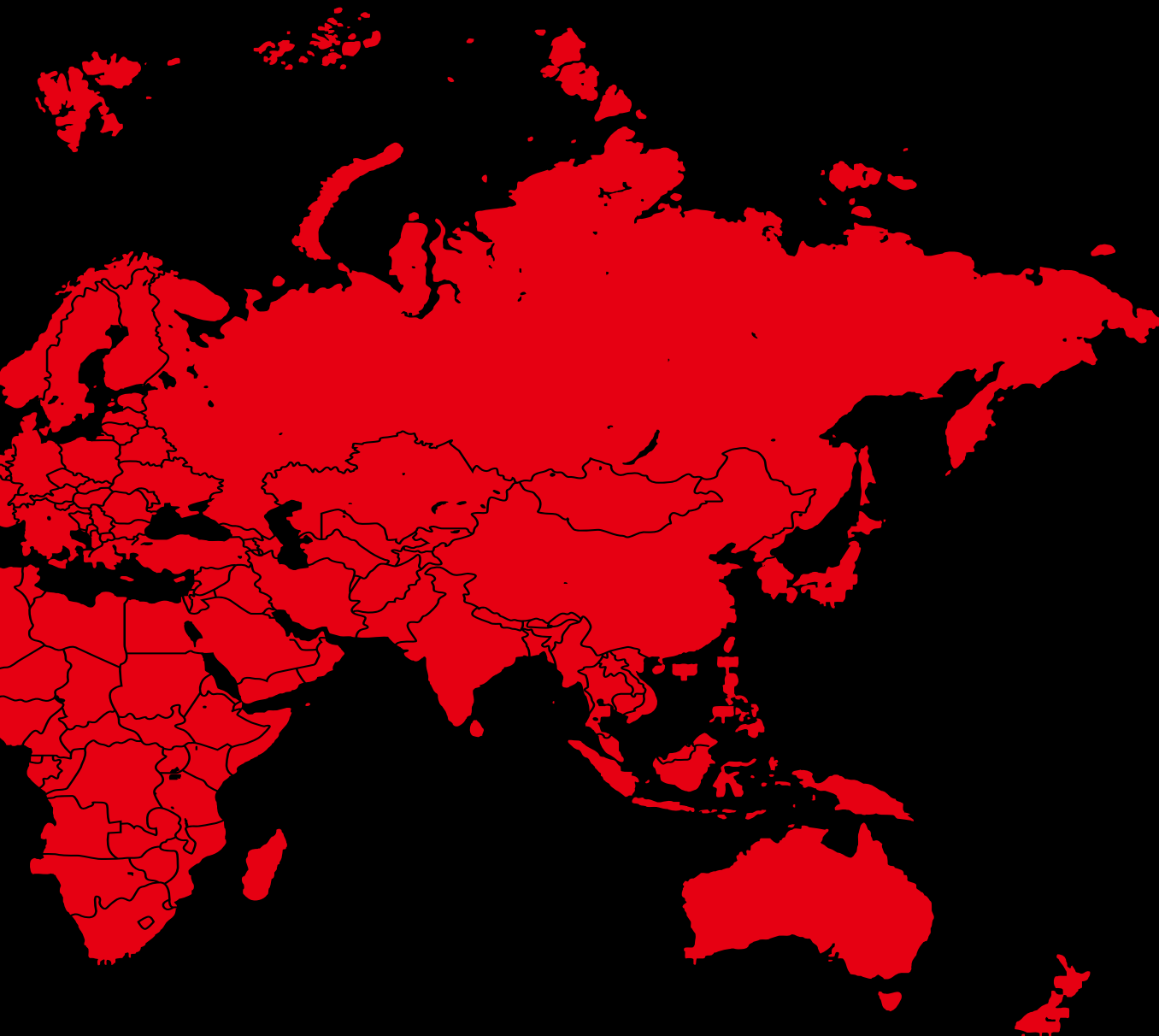

LEAH: A manufacturer leading to the forefront of the industry

LEAH - Rooted in Hong Kong, is dedicated to providing plumbing products of the highest level of safety and quality to its international clients and local clients, committed to addressing secondary pollution of drinking-water caused by plumbing products with excessive lead content.

World Health Organization has identified lead as one of ten chemicals of major public health concern and pointed out that lead is a cumulative toxicant that affects multiple body systems and is particularly harmful to young children. Lead can enter the human body by ingestion, inhalation and skin absorption. However, lead exposure is preventable.

Our products are made of lead-free copper (i.e. lead content less than 0.1%), and have acquired the General Acceptance status from the Hong Kong Water Supplies Department and fully complied with the requirement of "Reduction of Lead in Drinking Water Act" (i.e. the maximum lead content of plumbing product is 0.25%) formulated by the United States of America.

LEAH: Purpose

LEAH has long attached great importance to drinking-water safety and upholds the highest standard of business ethics to ensure safe and high quality plumbing products for clients around the world.

三重保障，六項檢測

耐酸測試

超過 60000 次酸性試劑清洗，表面無侵蝕痕迹，完美的耐腐蝕性，經得起每天的清潔洗劑親密接觸，廚衛清潔從此無憂。

耐腐測試

超過 200H 中性鹽霧測試，龍頭鍍層表面無腐蝕，在廚房多油或衛浴水蒸氣的環境裏，亦能長久保持表面光亮，輕鬆擁有愉悅的廚衛生活。

材料測試

苛刻的實時銅材料成分檢測，保證每一個龍頭（含鉛少於 0.1%）為標準銅材，不含雜質，耐酸性，抗氧化，使表面電鍍層更牢固，歷久彌新。

靜音測試

超過 60000 次酸性試劑清洗，表面無侵蝕痕迹，完美的耐腐蝕性，經得起每天的清潔洗劑親密接觸，廚衛清潔從此無憂。

壽命測試

超過 20 萬次開關使用壽命測試，手感保持順滑，每天開關龍頭 50 次，閥芯也能正常使用 10 年，品質生活長久相伴。

精度測試

超高水壓密封性測試，超過 16 公斤水壓力，超強度的閥體，能承受超高水壓，絕無應為水壓原因產生爆裂和滲漏的隱患。

Acid resistance test

More than 60000 times of acid reagent cleaning, no erosion marks on the surface, perfect corrosion resistance, able to withstand daily cleaning lotion, intimate contact, kitchen and toilet cleaning is no worries.

Corrosion resistance test

More than 200H neutral salt spray test, the surface of the lead plating has no corrosion, and it can also keep the surface bright and easy to have a pleasant kitchen and bathroom life in the environment of kitchen oil or bathroom.

Material testing

Real time copper material composition detection demanding, ensure each leading (lead less than 0.1%) as the standard copper, without impurities, acid resistance, oxidation resistance, surface plating more firmly, timeless.

Mute test

More than 60000 times of acid reagent cleaning, no erosion marks on the surface, perfect corrosion resistance, able to withstand daily cleaning lotion, intimate contact, kitchen and toilet cleaning is no worries.

Life test

More than 200 thousand switching service life test, feel smooth, 50 times a day switch faucet, the valve core can also be used for 10 years, the quality of life for a long time.

Precision test

Super high water pressure seal test, more than 16 kg of water pressure, super high strength valve body, can withstand ultra-high water pressure, and no need for water pressure causes burst and leakage hazards.

// 产品特性 // UNIQUE

CHARACTERISTICS



饮用水
Drinking water



顺滑技术
Slippery Technology



环保节水
Environmental protection
and water saving



光亮技术
Shiny Technology



解決方案

選擇最適合您
需求的產品

Solutions ahead

We care your concern
The best or nothing



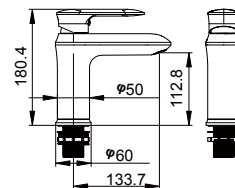
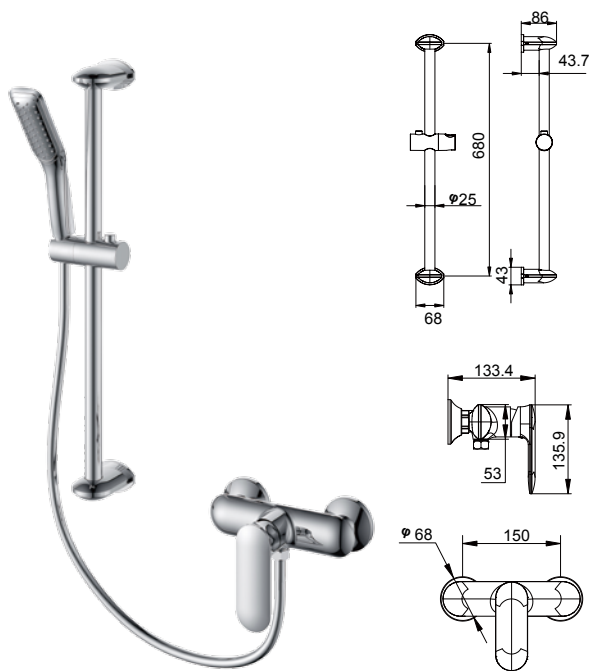

LE7824

黄铜单控面盆混合龙头(铬色)
Brass single controlled basin mixed faucet
(Chrome)

专利号 : 2017305232936
Patent number

检测标准 (欧盟) : BS EN1286 : 1999
Standard test (EU) BS EN12164 : 2016

检测报告:
Test Report

香港水务处证编号:
Hongkong water office
certificate number

LE7826

黄铜单控淋浴花洒冷水混合龙头(铬色)
Brass single control shower shower and hot water
mixed faucet (Chrome)

专利号 : 2017305235775
Patent number

检测标准 (欧盟) : BS EN1286 : 1999
Standard test (EU) BS EN12164 : 2016 &BS EN10088-1:2014

检测报告:
Test Report

香港水务处证编号:
Hongkong water office
certificate number

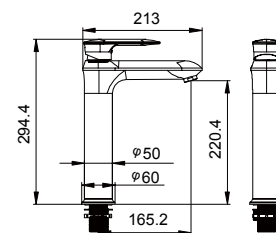

LE7825

黄铜单控面盆混合龙头(铬色)
Brass single controlled basin mixed faucet
(Chrome)

专利号 : 2017305232936
Patent number

检测标准 (欧盟) : BS EN1286 : 1999
Standard test (EU) BS EN12164 : 2016

检测报告:
Test Report

香港水务处证编号:
Hongkong water office
certificate number

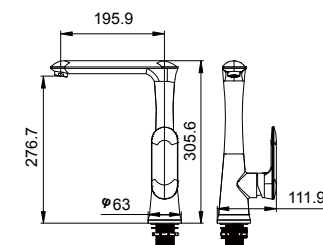
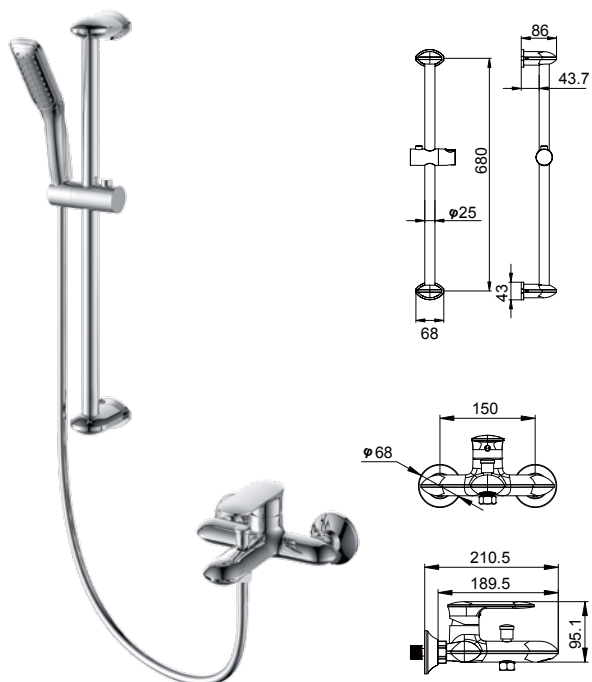

LE7827

黄铜单控浴缸花洒冷水混合龙头(铬色)
Brass single control bathtub sprinkler cold and
hot water mixed faucet (Chrome)

专利号 : 2017305240735
Patent number

检测标准 (欧盟) : BS EN1286 : 1999
Standard test (EU) BS EN12164 : 2016 &BS EN10088-1:2014

检测报告:
Test Report

香港水务处证编号:
Hongkong water office
certificate number

LE7828

黄铜单控厨房混合水龙头(铬色)
Brass single controlled kitchen mixed
faucet (Chrome)

专利号 : 2017305235811
Patent number

检测标准 (欧盟) : BS EN1286 : 1999
Standard test (EU) BS EN12164 : 2016

检测报告:
Test Report:

香港水务处证编号:
Hongkong water office
certificate number.



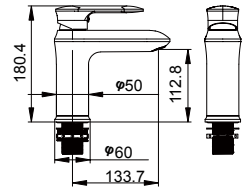
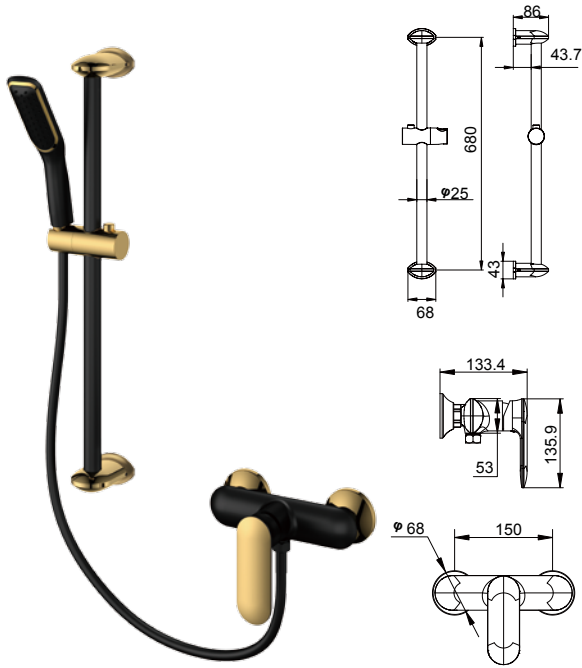

LE7824B

黄铜单控面盆混合龙头 (黑 + 金)
Brass single controlled basin mixed faucet (Black+Gold)

专利号 : 2017305232936
Patent number

检测标准 (欧盟) : BS EN1286 : 1999
Standard test (EU) BS EN12164 : 2016

检测报告:
Test Report

香港水务处证编号:
Hongkong water office
certificate number

LE7826B

黄铜单控淋浴花洒冷热水混合龙头 (黑 + 金)
Brass single control shower and hot water mixed faucet (Black+Gold)

专利号 : 2017305235775
Patent number

检测标准 (欧盟) : BS EN1286 : 1999
Standard test (EU) BS EN12164 : 2016 & BS EN10088-1:2014

检测报告:
Test Report

香港水务处证编号:
Hongkong water office
certificate number

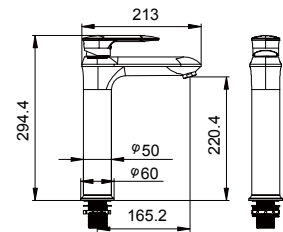

LE7825B

黄铜单控面盆混合龙头 (黑 + 金)
Brass single controlled basin mixed faucet (Black+Gold)

专利号 : 2017305232936
Patent number

检测标准 (欧盟) : BS EN1286 : 1999
Standard test (EU) BS EN12164 : 2016

检测报告:
Test Report

香港水务处证编号:
Hongkong water office
certificate number

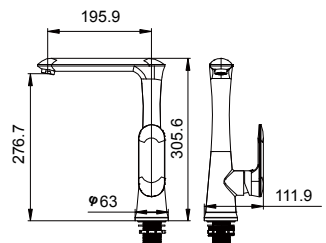
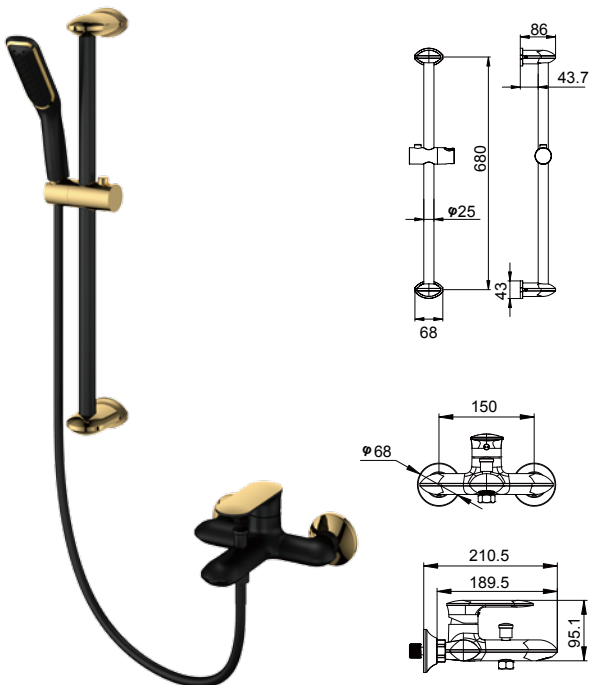

LE7827B

黄铜单控浴缸花洒冷热水混合龙头 (黑 + 金)
Brass single control bathtub sprinker cold and hot water mixed faucet (Black+Gold)

专利号 : 2017305240735
Patent number

检测标准 (欧盟) : BS EN1286 : 1999
Standard test (EU) BS EN12164 : 2016 & BS EN10088-1:2014

检测报告:
Test Report

香港水务处证编号:
Hongkong water office
certificate number

LE7828B

黄铜单控厨房混合水龙头 (黑 + 金)
Brass single controlled kitchen mixed faucet (Black+Gold)

专利号 : 2017305235811
Patent number

检测标准 (欧盟) : BS EN1286 : 1999
Standard test (EU) BS EN12164 : 2016

检测报告:
Test Report

香港水务处证编号:
Hongkong water office
certificate number



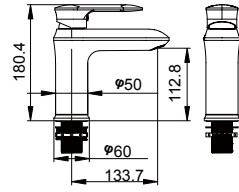
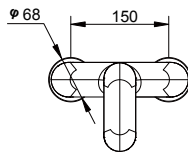
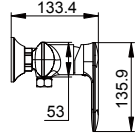
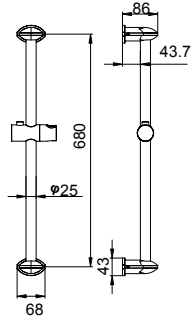

LE7824A

黄铜单控面盆混合龙头 (白+铬)
Brass single controlled basin mixed faucet (White+Chrome)

专利号: 2017305232936
Patent number

检测标准 (欧盟): BS EN1286 : 1999
Standard test (EU) BS EN12164 : 2016

检测报告:
Test Report

香港水务处证编号:
Hongkong water office
certificate number

LE7826A

黄铜单控淋浴花洒冷水热水混合龙头 (白+铬)
Brass single control shower sprayer and hot water mixed faucet (White+Chrome)

专利号: 2017305235775
Patent number

检测标准 (欧盟): BS EN1286 : 1999
Standard test (EU) BS EN12164 : 2016 & BS EN10088 - 1:2014

检测报告:
Test Report

香港水务处证编号:
Hongkong water office
certificate number

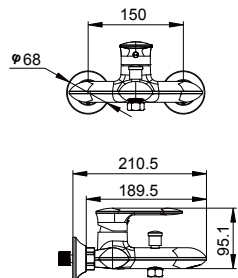
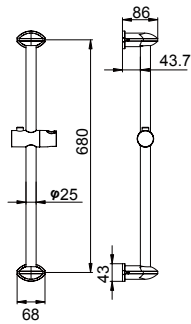
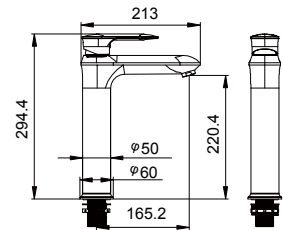

LE7825A

黄铜单控面盆混合龙头 (白+铬)
Brass single controlled basin mixed faucet (White+Chrome)

专利号: 2017305232936
Patent number

检测标准 (欧盟): BS EN1286 : 1999
Standard test (EU) BS EN12164 : 2016

检测报告:
Test Report

香港水务处证编号:
Hongkong water office
certificate number

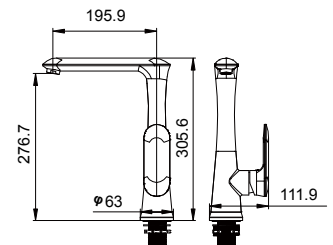

LE7827A

黄铜单控浴缸花洒冷水热水混合龙头 (白+铬)
Brass single control bathtub sprinker cold and hot water mixed faucet (White+Chrome)

专利号: 2017305240735
Patent number

检测标准 (欧盟): BS EN1286 : 1999
Standard test (EU) BS EN12164 : 2016 & BS EN10088 - 1:2014

检测报告:
Test Report

香港水务处证编号:
Hongkong water office
certificate number

LE7828A

黄铜单控厨房混合水龙头 (白+铬)
Brass single controlled kitchen mixed faucet (White+Chrome)

专利号: 2017305235811
Patent number

检测标准 (欧盟): BS EN1286 : 1999
Standard test (EU) BS EN12164 : 2016

检测报告:
Test Report

香港水务处证编号:
Hongkong water office
certificate number



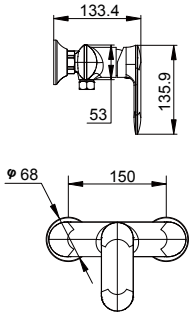
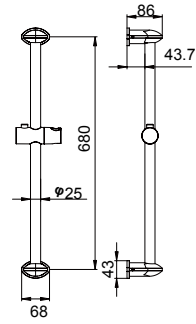

LE7826D

黄铜单控淋浴花洒冷热水混合龙头 (ORB)
Brass single control shower shower and hot water mixed faucet (ORB)

专利号 : 2017305235775
Patent number

检测标准 (欧盟) : BS EN1286 : 1999
Standard test (EU) BS EN12164 : 2016 & BS EN10088-1:2014

检测报告:
Test Report
香港水务处证编号:
Hongkong water office certificate number

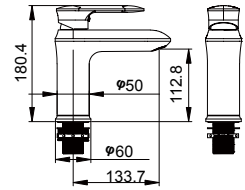

LE7824D

黄铜单控面盆混合龙头 (ORB)
Brass single controlled basin mixed faucet (ORB)

专利号 : 2017305232936
Patent number

检测标准 (欧盟) : BS EN1286 : 1999
Standard test (EU) BS EN12164 : 2016

检测报告:
Test Report
香港水务处证编号:
Hongkong water office certificate number

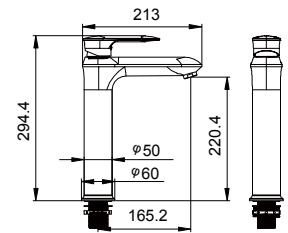

LE7825D

黄铜单控面盆混合龙头 (ORB)
Brass single controlled basin mixed faucet (ORB)

专利号 : 2017305232936
Patent number

检测标准 (欧盟) : BS EN1286 : 1999
Standard test (EU) BS EN12164 : 2016

检测报告:
Test Report
香港水务处证编号:
Hongkong water office certificate number

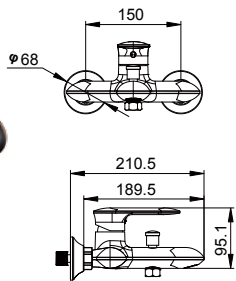
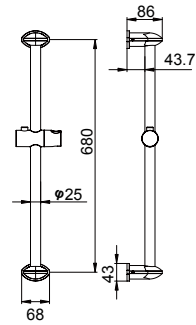

LE7827D

黄铜单控浴缸花洒冷热水混合龙头 (ORB)
Brass single control bathtub sprinkler cold and hot water mixed faucet (ORB)

专利号 : 2017305240735
Patent number

检测标准 (欧盟) : BS EN1286 : 1999
Standard test (EU) BS EN12164 : 2016 & BS EN10088-1:2014

检测报告:
Test Report
香港水务处证编号:
Hongkong water office certificate number

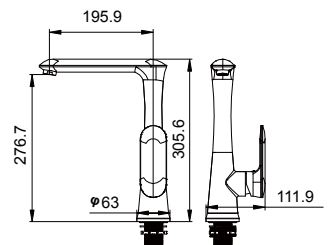

LE7828D

黄铜单控厨房混合水龙头 (ORB)
Brass single controlled kitchen mixed faucet (ORB)

专利号 : 2017305235811
Patent number

检测标准 (欧盟) : BS EN1286 : 1999
Standard test (EU) BS EN12164 : 2016

检测报告:
Test Report
香港水务处证编号:
Hongkong water office certificate number



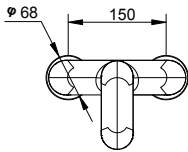
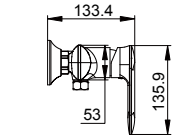
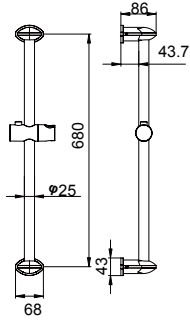

LE7826C

黄铜单控淋浴花洒冷水混合龙头 (橙 + 铬)
Brass single control shower and hot water mixed faucet (Orange+Chrome)

专利号 : 2017305235775
Patent number

检测标准 (欧盟) : BS EN1286 : 1999
Standard test (EU) BS EN12164 : 2016 & BS EN10088 - 1:2014

检测报告:
Test Report

香港水务处证编号:
Hongkong water office certificate number

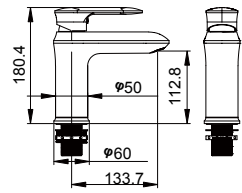

LE7824C

黄铜单控面盆混合龙头 (橙 + 铬)
Brass single controlled basin mixed faucet (Orange+Chrome)

专利号 : 2017305232936
Patent number

检测标准 (欧盟) : BS EN1286 : 1999
Standard test (EU) BS EN12164 : 2016

检测报告:
Test Report

香港水务处证编号:
Hongkong water office certificate number

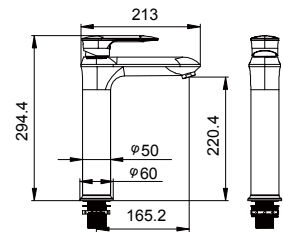

LE7825C

黄铜单控面盆混合龙头 (橙 + 铬)
Brass single controlled basin mixed faucet (Orange+Chrome)

专利号 : 2017305232936
Patent number

检测标准 (欧盟) : BS EN1286 : 1999
Standard test (EU) BS EN12164 : 2016

检测报告:
Test Report

香港水务处证编号:
Hongkong water office certificate number

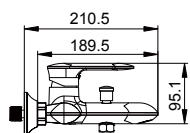
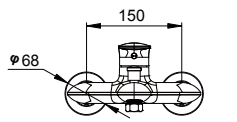
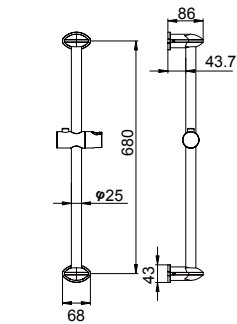

LE7827C

黄铜单控浴缸花洒冷水混合龙头 (橙 + 铬)
Brass single control bathtub sprinkler cold and hot water mixed faucet (Orange+Chrome)

专利号 : 2017305240735
Patent number

检测标准 (欧盟) : BS EN1286 : 1999
Standard test (EU) BS EN12164 : 2016 & BS EN10088 - 1:2014

检测报告:
Test Report

香港水务处证编号:
Hongkong water office certificate number

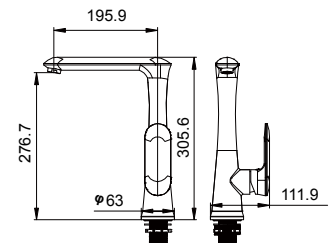

LE7828C

黄铜单控厨房混合水龙头 (橙 + 铬)
Brass single controlled kitchen mixed faucet (Orange+Chrome)

专利号 : 2017305235811
Patent number

检测标准 (欧盟) : BS EN1286 : 1999
Standard test (EU) BS EN12164 : 2016

检测报告:
Test Report

香港水务处证编号:
Hongkong water office certificate number

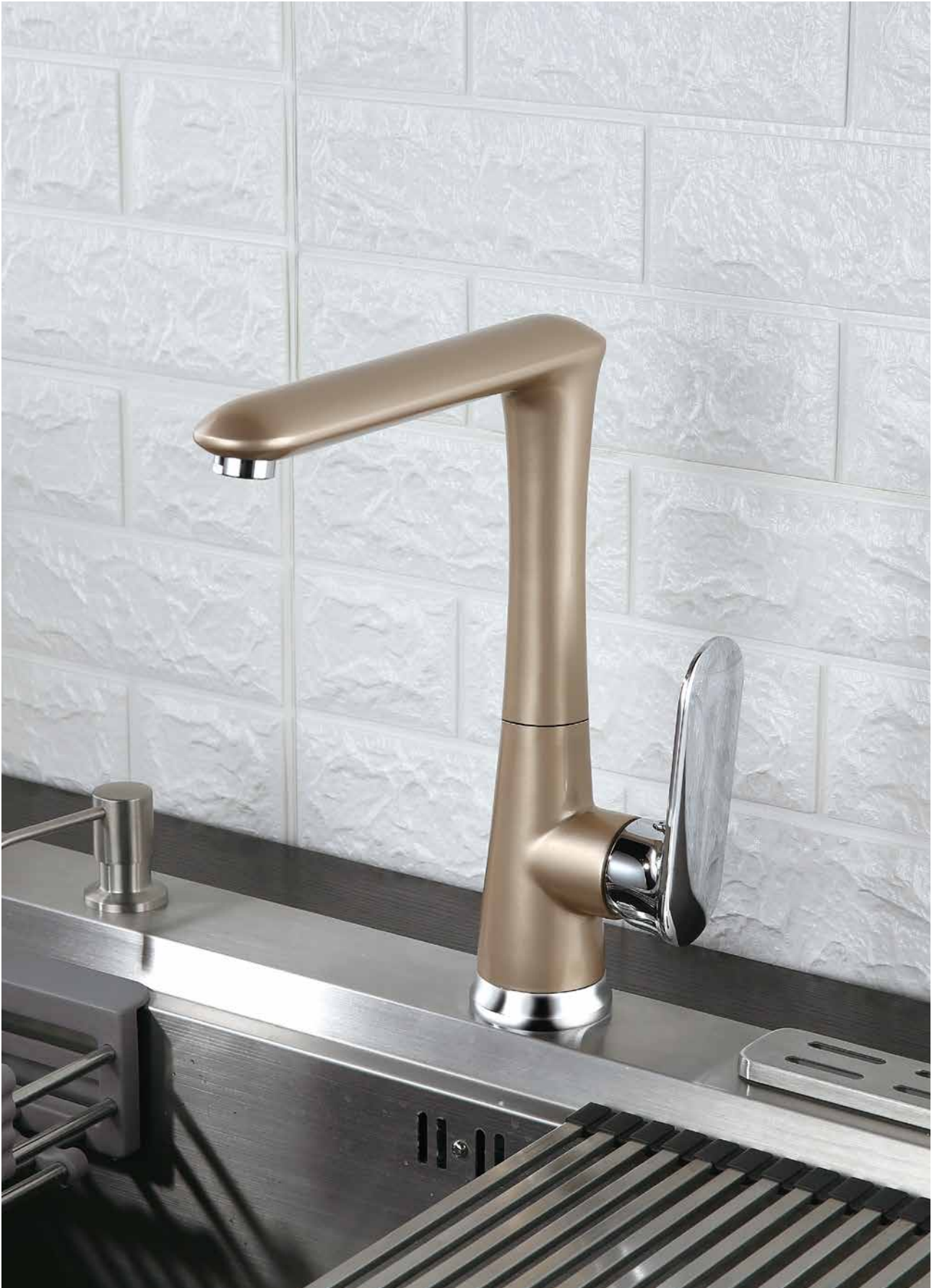

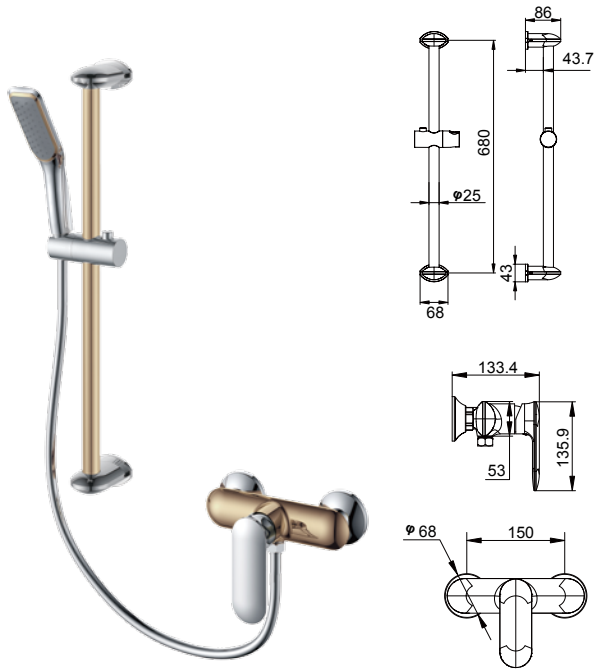

LE7824E

黄铜单控面盆混合龙头 (金 + 铬)
Brass single controlled basin mixed faucet (Gold+Chrome)

专利号: 2017305232936
Patent number

检测标准 (欧盟): BS EN1286 : 1999
Standard test (EU) BS EN12164 : 2016

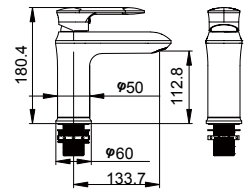

检测报告:
Test Report

香港水务处证编号:
Hongkong water office certificate number

LE7826E

黄铜单控淋浴花洒冷热水混合龙头 (金 + 铬)
Brass single control shower and hot water mixed faucet (Gold+Chrome)

专利号: 2017305235775
Patent number

检测标准 (欧盟): BS EN1286 : 1999
Standard test (EU) BS EN12164 : 2016 & BS EN10088 - 1:2014

检测报告:
Test Report

香港水务处证编号:
Hongkong water office certificate number

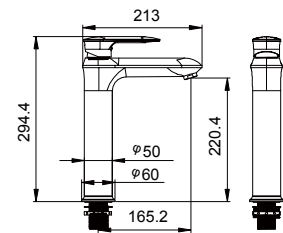

LE7825E

黄铜单控面盆混合龙头 (金 + 铬)
Brass single controlled basin mixed faucet (Gold+Chrome)

专利号: 2017305232936
Patent number

检测标准 (欧盟): BS EN1286 : 1999
Standard test (EU) BS EN12164 : 2016

检测报告:
Test Report

香港水务处证编号:
Hongkong water office certificate number

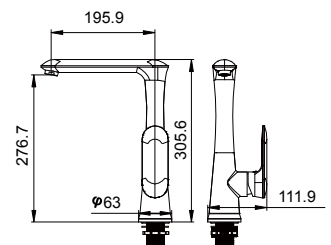
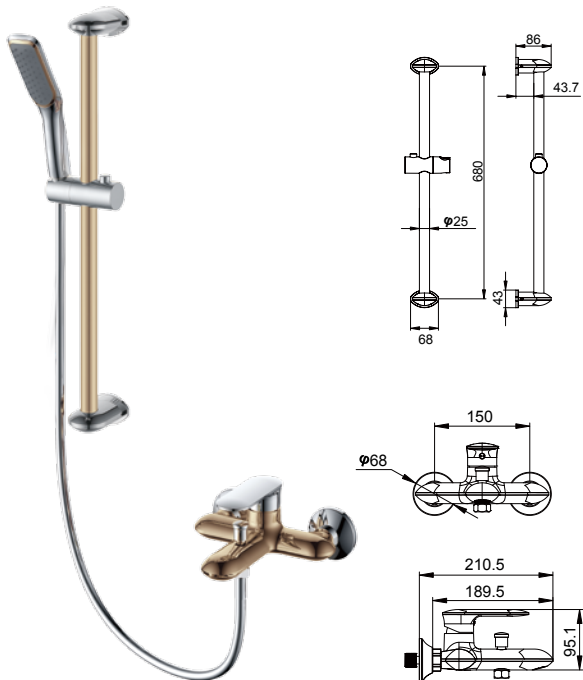

LE7827E

黄铜单控浴缸花洒冷热水混合龙头 (金 + 铬)
Brass single control bathtub sprinkler cold and hot water mixed faucet (Gold+Chrome)

专利号: 2017305240735
Patent number

检测标准 (欧盟): BS EN1286 : 1999
Standard test (EU) BS EN12164 : 2016 & BS EN10088 - 1:2014

检测报告:
Test Report

香港水务处证编号:
Hongkong water office certificate number

LE7828E

黄铜单控厨房混合水龙头 (金 + 铬)
Brass single controlled kitchen mixed faucet (Gold+Chrome)

专利号: 2017305235811
Patent number

检测标准 (欧盟): BS EN1286 : 1999
Standard test (EU) BS EN12164 : 2016

检测报告:
Test Report

香港水务处证编号:
Hongkong water office certificate number



水務署
Water Supplies Department

香港灣仔告士打道七號入境事務大樓
Immigration Tower, 7 Gloucester Road, Hong Kong

電子郵件
e-mail wsdinfo@wsd.gov.hk

電話
Telephone 2829 4355 圖文傳真
Facsimile 2824 0578

傳真
Reference (4) in WSD 3321/17 Pt.1 T/J(1424)

12 December 2017

Kin Hing Engineering Industrial Company Limited
Flat F, 24/F, Block 2, Golden Dragon Industrial Centre,
162-170 Tai Lin Pai Road, N.T., Hong Kong

(Attn.: 陳煊棠先生)

Dear Sir,

Approval of "LEAH" Basin Mixer

Your letters ref. KH/LE/WSD/GA/LE801-01 dated 15 November 2017 and ref. KH/LE/WSD/GA/LE801-02 dated 27 November 2017 refer.

Having considered the test report ref. J21439Ar1 issued on 21 November 2017 by Nutek Systems (HK) Ltd., this Authority accepts that the fitting described below complies with, and its use when correctly installed does not contravene, the Waterworks Ordinance and Regulations.

Name of Manufacturer: Bolle Sanitary Ware (Kaiping) Co Ltd

Country of Origin: China

Brand: Leah

Details of Fitting: 1/2" Single lever basin mixer

Model: LE801

Body Markings: Leah

Expiry Date: 25 September 2022

Acceptance Reference No. C20170764

Page: 1

This Authority hereby permits the use of the above fitting in fresh water plumbing systems subject to full adherence to Waterworks installation requirements. In particular, you are required to draw your customers' attention to the following requirement-

"The cold water supply to the fitting shall be drawn from the same source that supplies the hot water apparatus so as to provide a balanced pressure and to obviate the risk of scalding in the event of a restriction or failure in the water supply."

A condition of this acceptance is that the fitting to be installed shall be replicas of the sample as certified by the testing agent mentioned above and without modifications. This acceptance may be withdrawn at any time if the standard of the fitting installed fails to meet that of the approved sample or if the fitting is found to be unsuitable for use in fresh water plumbing systems.

This acceptance is only applicable to the main body of the fitting, unless other specified.

For the use of the fitting in any project, the Acceptance Reference Number at the bottom of this letter must be quoted as a means of identification of acceptance of the fitting by this Authority.

Should you have any enquiries, please contact our Engineer Mr. Terry KUNG at tel. no. 2294 2656.

Yours faithfully,

(CHAN Chung Kun)
for Water Authority

c.c. WSD 3321/1/82] - without catalogue
ME/MC] - with soft copy only

Acceptance Reference No. C20170764

Page: 2

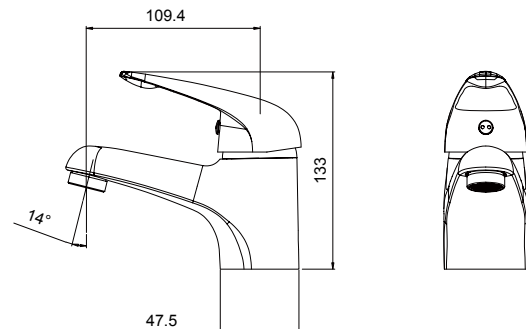

LE801

镀铬黄铜单控面盆混合龙头
Chromium Plated Brass Basin Mixer
Pillar Tap With Lever Handle

檢測報告: J21439A
Test Report

檢測標準 (歐盟) : BS EN1286 : 1999
Standard test (EU) BS EN12164: 2016

香港水務處認證編號: C20170764
Certification number of
Hongkong water service



水務署
Water Supplies Department

香港灣仔告士打道七號入境事務大樓
Immigration Tower, 7 Gloucester Road, Hong Kong

電子郵遞
e-mail wsdinfo@wsd.gov.hk

電話 2829 4355 圖文傳真 2824 0578
Telephone Facsimile

編號 (4) in WSD 3321/17 Pt.1 T/J(1425)
Reference

12 December 2017

Kin Hing Engineering Industrial Company Limited
Flat F, 24/F, Block 2, Golden Dragon Industrial Centre,
162-170 Tai Lin Pai Road, N.T., Hong Kong

(Attn.: 陳煊榮先生)

Dear Sir,

Approval of "LEAH" Shower Mixer

Your letters ref. KH/LE/WSD/GA/LE802-01 dated 15 November 2017 and ref. KH/LE/WSD/GA/LE802-02 dated 27 November 2017 refer.

Having considered the test report ref. J21774A issued on 1 November 2017 by Nutek Systems (HK) Ltd., this Authority accepts that the fitting described below complies with, and its use when correctly installed does not contravene, the Waterworks Ordinance and Regulations.

Name of Manufacturer: Bolle Sanitary Ware (Kaiping) Co Ltd

Country of Origin: China

Brand: Leah

Details of Fitting: 1/2" Single lever shower mixer

Model: LE802

Body Markings: Leah

Expiry Date: 31 August 2022

Acceptance Reference No. C20170765

Page: 1



LE802

镀铬黄铜单控花洒混合龙头
Chromium Plated Brass Shower Mixer
Tap With Lever Handle

檢測報告: J21774A
Test Report

检测标准 (欧盟): BS EN1286 : 1999
Standard test (EU) BS EN12164: 2016
&BS EN10088-1:2014

香港水務處認證編號: C20170765
Certification number of
Hongkong water service

This Authority hereby permits the use of the above fitting in fresh water plumbing systems subject to full adherence to Waterworks installation requirements. In particular, you are required to draw your customers' attention to the following requirement-

"The cold water supply to the fitting shall be drawn from the same source that supplies the hot water apparatus so as to provide a balanced pressure and to obviate the risk of scalding in the event of a restriction or failure in the water supply." AND

"The shower head or handspray should not be placed in submerged conditions and should be securely fixed to the original position after use."

A condition of this acceptance is that the fitting to be installed shall be replicas of the sample as certified by the testing agent mentioned above and without modifications. This acceptance may be withdrawn at any time if the standard of the fitting installed fails to meet that of the approved sample or if the fitting is found to be unsuitable for use in fresh water plumbing systems.

This acceptance is only applicable to the main body of the fitting, unless other specified.

For the use of the fitting in any project, the Acceptance Reference Number at the bottom of this letter must be quoted as a means of identification of acceptance of the fitting by this Authority.

Should you have any enquiries, please contact our Engineer Mr. Terry KUNG at tel. no. 2294 2656.

Yours faithfully,

(CHAN Chung Kun)
for Water Authority

c.c. WSD 3321/1/82] - without catalogue
ME/MC] - with soft copy only

Acceptance Reference No. C20170765

Page: 2

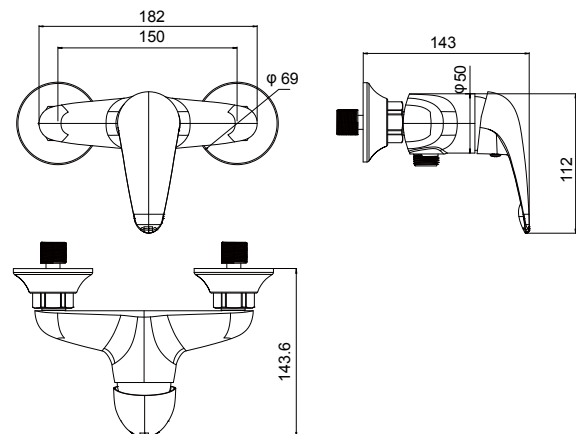



水務署
Water Supplies Department

香港灣仔告士打道七號入境事務大樓
Immigration Tower, 7 Gloucester Road, Hong Kong

電子郵件 e-mail
wsdinfo@wsd.gov.hk

電話 Telephone 2829 4355 圖文傳真 Facsimile 2824 0578

編號 Reference (4) in WSD 3321/17 Pt.1 T/J(1426)

12 December 2017

Kin Hing Engineering Industrial Company Limited
Flat F, 24/F, Block 2, Golden Dragon Industrial Centre,
162-170 Tai Lin Pai Road, N.T., Hong Kong

(Attn.: 陳煊榮先生)

Dear Sir,

Approval of "LEAH" Bath Mixer

Your letters ref. KH/LE/WSD/GA/LE803-01 dated 15 November 2017 and ref. KH/LE/WSD/GA/LE803-02 dated 27 November 2017 refer.

Having considered the test report ref. J21775Ar1 issued on 22 November 2017 by Nutek Systems (HK) Ltd., this Authority accepts that the fitting described below complies with, and its use when correctly installed does not contravene, the Waterworks Ordinance and Regulations.

Name of Manufacturer: Bolle Sanitary Ware (Kaiping) Co Ltd

Country of Origin: China

Brand: Leah

Details of Fitting: 1/2" Single lever bath mixer

Model: LE803

Body Markings: Leah

Expiry Date: 10 September 2022

Acceptance Reference No. C20170766

Page: 1



This Authority hereby permits the use of the above fitting in fresh water plumbing systems subject to full adherence to Waterworks installation requirements. In particular, you are required to draw your customers' attention to the following requirement-

"The cold water supply to the fitting shall be drawn from the same source that supplies the hot water apparatus so as to provide a balanced pressure and to obviate the risk of scalding in the event of a restriction or failure in the water supply." AND

"The shower head or handspray should not be placed in submerged conditions and should be securely fixed to the original position after use."

A condition of this acceptance is that the fitting to be installed shall be replicas of the sample as certified by the testing agent mentioned above and without modifications. This acceptance may be withdrawn at any time if the standard of the fitting installed fails to meet that of the approved sample or if the fitting is found to be unsuitable for use in fresh water plumbing systems.

This acceptance is only applicable to the main body of the fitting, unless other specified.

For the use of the fitting in any project, the Acceptance Reference Number at the bottom of this letter must be quoted as a means of identification of acceptance of the fitting by this Authority.

Should you have any enquiries, please contact our Engineer Mr. Terry KUNG at tel. no. 2294 2656.

Yours faithfully,

(CHAN Chung Kun)
for Water Authority

c.c. WSD 3321/1/82] - without catalogue
ME/MC] - with soft copy only

Acceptance Reference No. C20170766

Page: 2

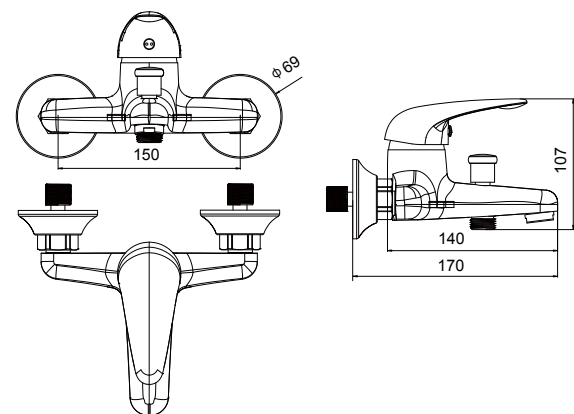

LE803

鍍鉻黃銅單控浴缸混合龍頭
Chromium Plated Brass Bath Mixer
Tap With Lever Handle

檢測報告: J21775A
Test Report

檢測標準 (歐盟) : BS EN1286 : 1999
Standard test (EU) BS EN12164: 2016
&BS EN10088-1:2014

香港水務處認證編號: C20170766
Certification number of
Hongkong water service



水務署
Water Supplies Department

香港灣仔告士打道七號入境事務大樓
Immigration Tower, 7 Gloucester Road, Hong Kong

電子郵遞
e-mail wsdinfo@wsd.gov.hk

電話
Telephone 2829 4355 圖文傳真
Facsimile 2824 0578

編號
Reference (2) in WSD 3321/17 Pt.1 T/J(1427)

4 December 2017

Kin Hing Engineering Industrial Company Limited
Flat F, 24/F, Block 2, Golden Dragon Industrial Centre,
162-170 Tai Lin Pai Road, N.T., Hong Kong

(Attn.: 陳煊棠先生)

Dear Sir,

Approval of "LEAH" Sink Mixer

Your letter ref. KH/LE/WSD/GA/LE804-01 dated 15 November 2017 refers.

Having considered the test report ref. J21776A issued on 9 November 2017 by Nutek Systems (HK) Ltd., this Authority accepts that the fitting described below complies with, and its use when correctly installed does not contravene, the Waterworks Ordinance and Regulations.

Name of Manufacturer: Bolle Sanitary Ware (Kaiping) Co Ltd

Country of Origin: China

Brand: Leah

Details of Fitting: 3/8" Single lever sink mixer

Model: LE804

Body Markings: Leah

Expiry Date: 25 September 2022

This Authority hereby permits the use of the above fitting in fresh water plumbing systems subject to full adherence to Waterworks installation requirements. In particular, you are required to draw your customers' attention to the following requirement-

"The cold water supply to the fitting shall be drawn from the same source that supplies the hot water apparatus so as to provide a balanced pressure and to obviate the risk of scalding in the event of a restriction or failure in the water supply."

A condition of this acceptance is that the fitting to be installed shall be replicas of the sample as certified by the testing agent mentioned above and without modifications. This acceptance may be withdrawn at any time if the standard of the fitting installed fails to meet that of the approved sample or if the fitting is found to be unsuitable for use in fresh water plumbing systems.

This acceptance is only applicable to the main body of the fitting, unless other specified.

For the use of the fitting in any project, the Acceptance Reference Number at the bottom of this letter must be quoted as a means of identification of acceptance of the fitting by this Authority.

Should you have any enquiries, please contact our Engineer Mr. Terry KUNG at tel. no. 2294 2656.

Yours faithfully,

(CHAN Chung Kun)
for Water Authority

c.c. WSD 3321/1/82] - without catalogue
ME/MC] - with soft copy only

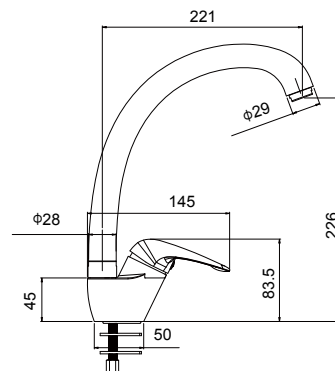

LE804

鍍鉻黃銅單控廚房混合龍頭
Chromium Plated Brass Sink Mixer
Pillar Tap With Lever Handle

檢測標準 (歐盟) : BS EN1286 : 1999
Standard test (EU) BS EN12164: 2016

檢測報告: J21776A
Test Report

香港水務處認證編號: C20170746

Certification number of
Hongkong water service



水務署
Water Supplies Department

香港灣仔告士打道七號入境事務大樓
Immigration Tower, 7 Gloucester Road, Hong Kong

電子郵件
e-mail wsdinfo@wsd.gov.hk

電話
Telephone 2829 4355 圖文傳真
Facsimile 2824 0578

編號
Reference (2) in WSD 3321/17 Pt.1 T/J(1428)

4 December 2017

Kin Hing Engineering Industrial Company Limited
Flat F, 24/F, Block 2, Golden Dragon Industrial Centre,
162-170 Tai Lin Pai Road, N.T., Hong Kong

(Attn.: 陳煊棠先生)

Dear Sir,

Approval of "LEAH" Bib Tap

Your letter ref. KH/LE/WSD/GA/LE824-01 dated 15 November 2017 refers.

Having considered the test report ref. J21777A issued on 1 November 2017 by Nutek Systems (HK) Ltd., this Authority accepts that the fitting described below complies with, and its use when correctly installed does not contravene, the Waterworks Ordinance and Regulations.

Name of Manufacturer: Bolle Sanitary Ware (Kaiping) Co Ltd

Country of Origin: China

Brand: Leah

Details of Fitting: 1/2" Brass bib tap

Model: LE824

Body Markings: Leah
LE824

Expiry Date: 25 September 2022

Acceptance Reference No. C20170747

Page: 1

This Authority hereby permits the use of the above fitting in fresh water plumbing systems subject to full adherence to Waterworks installation requirements.

A condition of this acceptance is that the fitting to be installed shall be replicas of the sample as certified by the testing agent mentioned above and without modifications. This acceptance may be withdrawn at any time if the standard of the fitting installed fails to meet that of the approved sample or if the fitting is found to be unsuitable for use in fresh water plumbing systems.

This acceptance is only applicable to the main body of the fitting, unless other specified.

For the use of the fitting in any project, the Acceptance Reference Number at the bottom of this letter must be quoted as a means of identification of acceptance of the fitting by this Authority.

Should you have any enquiries, please contact our Engineer Mr. Terry KUNG at tel. no. 2294 2656.

Yours faithfully,

(CHAN Chung Kun)
for Water Authority

c.c. WSD 3321/1/82] - without catalogue
ME/MC] - with soft copy only

Acceptance Reference No. C20170747

Page: 2

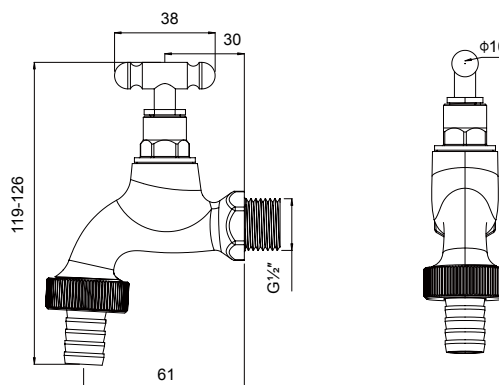

LE824

黃銅洗衣機龍頭
Brass Washing Machine Bib Tap

檢測報告: J21777A
Test Report

檢測標準 (歐盟) : BS EN200 : 2008
Standard test (EU) BS EN12164: 2016

香港水務處認證編號: C20170747
Certification number of
Hongkong water service



水務署
Water Supplies Department

香港灣仔告士打道七號入境事務大樓
Immigration Tower, 7 Gloucester Road, Hong Kong

電子郵件 wsdinfo@wsd.gov.hk
e-mail

電話 2829 4355 圖文傳真 2824 0578
Telephone Facsimile

編號 (2) in WSD 3321/17 Pt.1 T/J(1428)
Reference

4 December 2017

Kin Hing Engineering Industrial Company Limited
Flat F, 24/F, Block 2, Golden Dragon Industrial Centre,
162-170 Tai Lin Pai Road, N.T., Hong Kong

(Attn.: 陳煊棠先生)

Dear Sir,

Approval of "LEAH" Bib Tap

Your letter ref. KH/LE/WSD/GA/LE824-01 dated 15 November 2017 refers.

Having considered the test report ref. J21777A issued on 1 November 2017 by Nutek Systems (HK) Ltd., this Authority accepts that the fitting described below complies with, and its use when correctly installed does not contravene, the Waterworks Ordinance and Regulations.

Name of Manufacturer: Bolle Sanitary Ware (Kaiping) Co Ltd

Country of Origin: China

Brand: Leah

Details of Fitting: 1/2" Brass bib tap

Model: LE824

Body Markings: Leah
LE824

Expiry Date: 25 September 2022

Acceptance Reference No. C20170747

Page: 1

This Authority hereby permits the use of the above fitting in fresh water plumbing systems subject to full adherence to Waterworks installation requirements.

A condition of this acceptance is that the fitting to be installed shall be replicas of the sample as certified by the testing agent mentioned above and without modifications. This acceptance may be withdrawn at any time if the standard of the fitting installed fails to meet that of the approved sample or if the fitting is found to be unsuitable for use in fresh water plumbing systems.

This acceptance is only applicable to the main body of the fitting, unless other specified.

For the use of the fitting in any project, the Acceptance Reference Number at the bottom of this letter must be quoted as a means of identification of acceptance of the fitting by this Authority.

Should you have any enquiries, please contact our Engineer Mr. Terry KUNG at tel. no. 2294 2656.

Yours faithfully,

(CHAN Chung Kun)
for Water Authority

c.c. WSD 3321/1/82] - without catalogue
ME/MC] - with soft copy only

Acceptance Reference No. C20170747

Page: 2

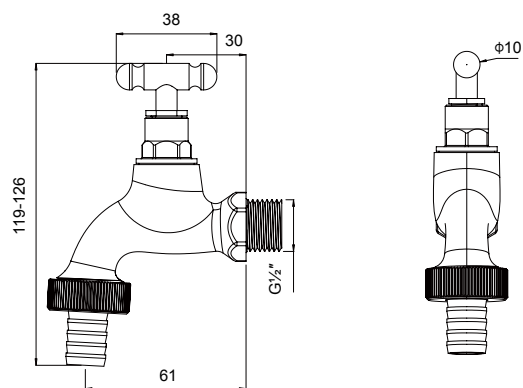

LE824

镀铬黄铜洗衣机龙头
Brass Washing Machine Bib Tap

檢測報告: J21777A
Test Report

檢測标准 (欧盟): BS EN200 : 2008
Standard test (EU) BS EN12164: 2016

香港水務處認證編號: C20170747
Certification number of
Hongkong water service

WATER SELF-CLEAN SYSTEM

陶瓷產品系列採用隧道窯燒制，保證了釉面的燒結硬度和光滑性。陶瓷在燒制過程中溫度變化小，成品具有不易龜裂，耐急冷急熱性好的特點。

The series of ceramic products are burned by tunnel kiln to ensure the hardness and smoothness of the glaze. In the process of making ceramics, the temperature change is small, the finished product is not easy to crack, and it has the characteristics of good cold and quick heat resistance.

// 產品特性 // UNIQUE CHARACTERISTICS

管道施釉
技術

*Pipe glazing
technology*

自潔釉面
技術

*Self cleaning glaze
technology*

高超抗菌
技術

*Antiseptic
technology*





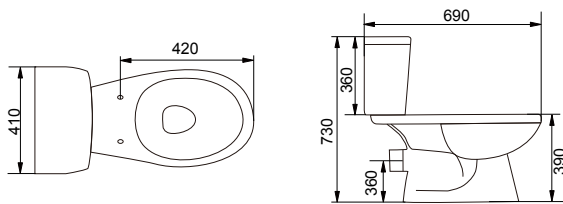

LE603

檢測報告:
Test Report

直衝式高咀分離套廁
Straight into the high Tsui separation sets of toilet

檢測標準 (歐盟) : BS7358:1990 BS5503 Part:1990
Standard test (EU) BS3402:1969 BS EN997:2003

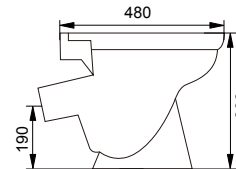
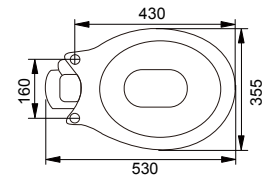

LE601

檢測報告: J22332r1

Test Report

直衝式分離座廁 (高咀 - 無氣孔)

Wash down P-trap toilet bowl without vent hole

檢測標準 (歐盟): BS EN 33: 2011 BS 3402:1969

Standard test (EU)

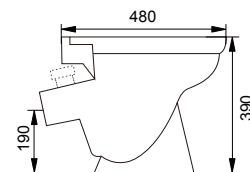
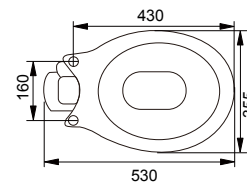

LE601L

檢測報告: J22332r1

Test Report

直衝式分離座廁 (高咀 - 左氣孔)

Wash down P-trap toilet bowl with Left vent hole

檢測標準 (歐盟): BS EN 33: 2011 BS 3402:1969

Standard test (EU)

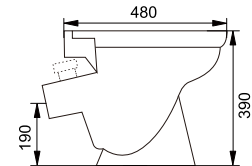
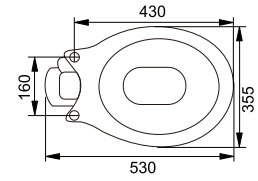

LE601R

檢測報告: J22332r1
Test Report

直衝式分離座廁 (高咀 - 右氣孔)

Wash down P-trap toilet bowl with Right vent hole

檢測標準 (歐盟): BS EN 33: 2011 BS 3402:1969

Standard test (EU)

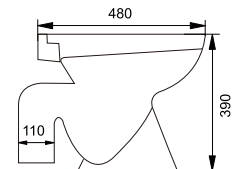
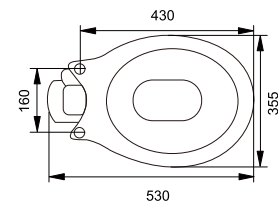

LE602

檢測報告: J22333r1
Test Report

直衝式分離座廁 (象咀 - 無氣孔)

Wash down S-trap toilet bowl without vent hole

檢測標準 (歐盟): BS EN 33: 2011 BS 3402:1969

Standard test (EU)

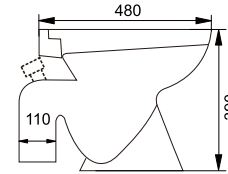
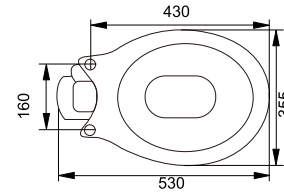

LE602L

檢測報告: J22333r1

Test Report

直衝式分離座廁 (象咀 - 左氣孔)

Wash down S-trap toilet bowl with Left vent hole

檢測標準 (歐盟): BS EN 33: 2011 BS 3402:1969

Standard test (EU)

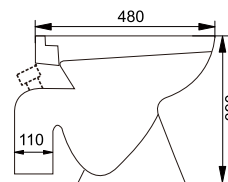
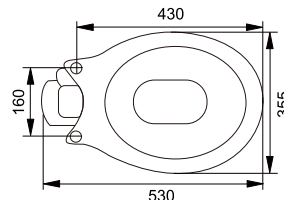

LE602R

檢測報告: J22333r1

Test Report

直衝式分離座廁 (象咀 - 右氣孔)

Wash down S-trap toilet bowl with Right vent hole

檢測標準 (歐盟): BS EN 33: 2011 BS 3402:1969

Standard test (EU)

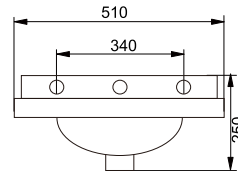
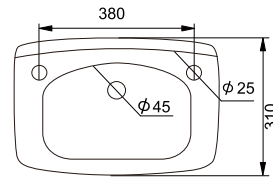

LE201

檢測報告：
Test Report

雙孔掛牆面盆

Two tap holes wash basin

檢測標準 (歐盟) : BS 1188: 1974 BS 3402:1969
Standard test (EU)

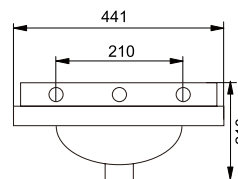
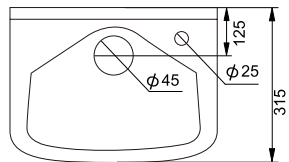

LE202

檢測報告：
Test Report

單孔掛牆面盆

Single tap hole wash basin

檢測標準 (歐盟) : BS 1188: 1974 BS 3402:1969
Standard test (EU)

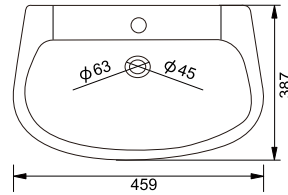
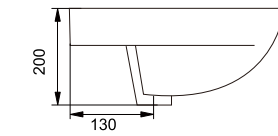

LE203

檢測報告:

Test Report

單孔半圓掛牆面盆

Semi circle wash basin single tap hole

檢測標準 (歐盟) : BS 1188: 1974 BS 3402:1969

Standard test (EU)

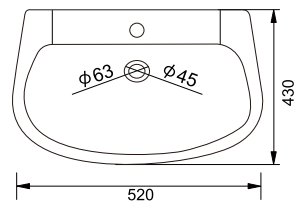
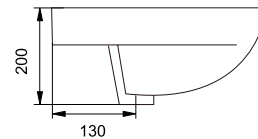

LE204

檢測報告:

Test Report

單孔半圓掛牆面盆

Semi circle wash basin single tap hole

檢測標準 (歐盟) : BS 1188: 1974 BS 3402:1969

Standard test (EU)

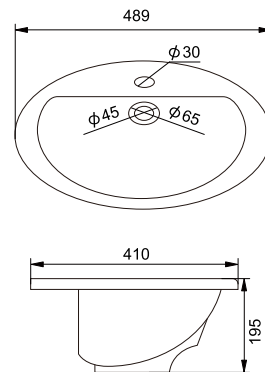

LE205(1)

檢測報告: J21966

Test Report

單孔鵝蛋半臺上式面盆

Semi recessed wash basin single hole

檢測標準 (歐盟): BS 1188: 1974 BS 3402:1969

Standard test (EU)

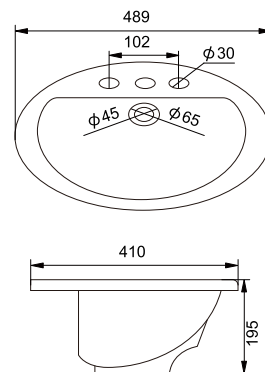

LE205(3)

檢測報告: J21966

Test Report

三孔鵝蛋半臺上式面盆

Semi recessed wash basin three holes

檢測標準 (歐盟): BS 1188: 1974 BS 3402:1969

Standard test (EU)



LE381

檢測報告:

Test Report

白瓷低水箱

White porcelain low water tank

檢測標準 (歐盟): BS 3402:1969

Standard test (EU)

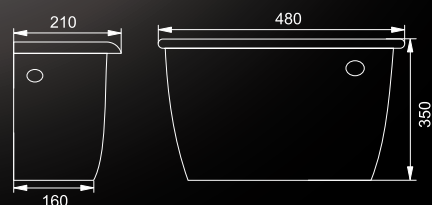

水箱採用優質排水閥，排水能力強勁，補水迅速，經多次耐用實驗，使用壽命長，相當于與普通家庭使用 20 萬次以上。

The water tank adopts high quality drainage valve, which has strong drainage capacity and rapid replenishment. After many times of durable experiments, the service life is long, equivalent to more than 200,000 times that of ordinary families.

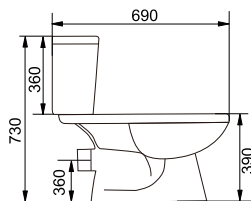
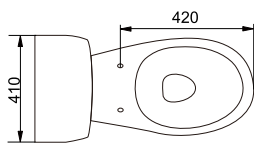

HM203U

检测报告：J17549rl
Test Report

直衝式高咀分離套廁
Straight into the high Tsui separation sets of toilet

檢測標準 (歐盟) : BS7358:1990 BS5503 Part:1990
Standard test (EU) BS3402:1969 BS EN997:2003

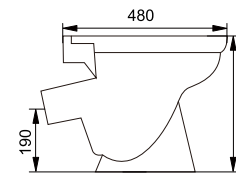
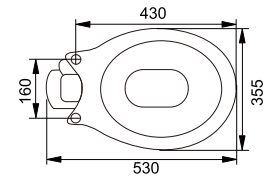

WP1810

檢測報告: J22206r1

Test Report

直衝式分離座廁 (高咀 - 無氣孔)

Wash down P-trap toilet bowl without vent hole

檢測標準 (歐盟): BS EN 33: 2011 BS 3402:1969

Standard test (EU)

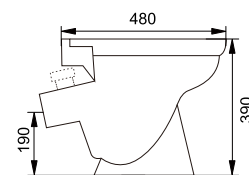
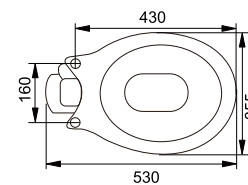

WP1810L

檢測報告: J22206r1

Test Report

直衝式分離座廁 (高咀 - 左氣孔)

Wash down P-trap toilet bowl with Left vent hole

檢測標準 (歐盟): BS EN 33: 2011 BS 3402:1969

Standard test (EU)

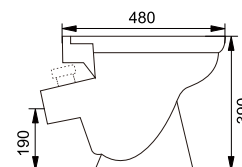
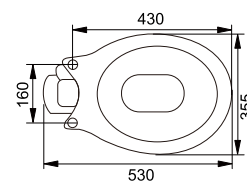

WP1810R

檢測報告: J22206rl

Test Report

直衝式分離座廁 (高咀 - 右氣孔)

Wash down P-trap toilet bowl with Right vent hole

檢測標準 (歐盟): BS EN 33: 2011 BS 3402:1969

Standard test (EU)

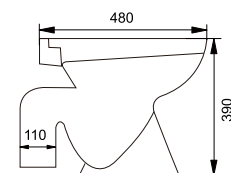
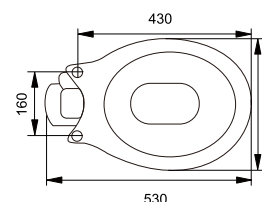

WS1820

檢測報告: J22207rl

Test Report

直衝式分離座廁 (象咀 - 無氣孔)

Wash down S-trap toilet bowl without vent hole

檢測標準 (歐盟): BS EN 33: 2011 BS 3402:1969

Standard test (EU)

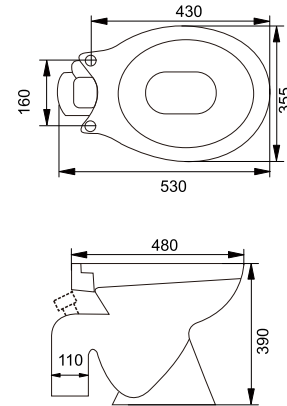

WS1820L

檢測報告: J22207rl
Test Report

直衝式分離座廁 (象咀 - 左氣孔)
Wash down S-trap toilet bowl with Left vent hole

檢測標準 (歐盟): BS EN 33: 2011 BS 3402:1969
Standard test (EU)

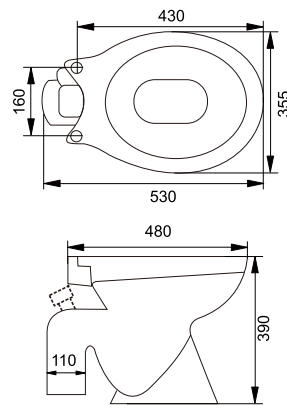

WS1820R

檢測報告: J22207rl
Test Report

直衝式分離座廁 (象咀 - 右氣孔)
Wash down S-trap toilet bowl with Right vent hole

檢測標準 (歐盟): BS EN 33: 2011 BS 3402:1969
Standard test (EU)

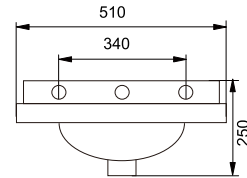
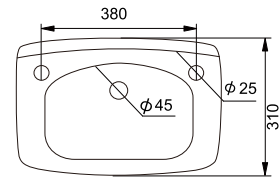

HM281

檢測報告: J21963

Test Report

雙孔掛牆面盆

Two tap holes wash basin

檢測標準 (歐盟): BS 1188: 1974 BS 3402:1969

Standard test (EU)

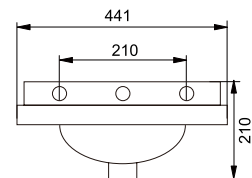
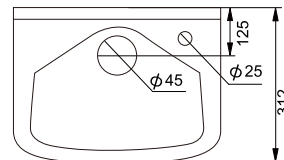

HM283

檢測報告: J21964

Test Report

單孔掛牆面盆

Single tap hole wash basin

檢測標準 (歐盟): BS 1188: 1974 BS 3402:1969

Standard test (EU)

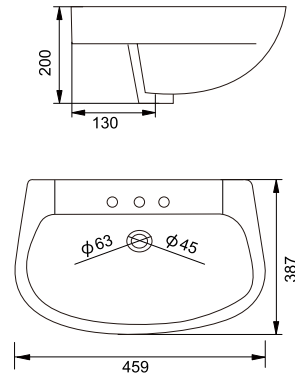

HM635-3H

檢測報告: J17453r1

Test Report

三孔半圓掛牆面盆

Semi circle wash basin three tap hole

檢測標準 (歐盟): BS 1188: 1974 BS 3402:1969

Standard test (EU)

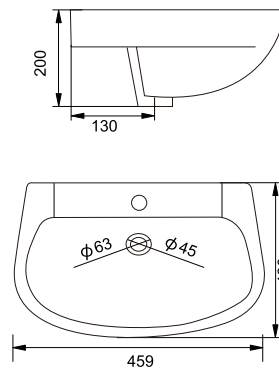

HM635

檢測報告: J17453r1

Test Report

單孔半圓掛牆面盆

Semi circle wash basin single tap hole

檢測標準 (歐盟): BS 1188: 1974 BS 3402:1969

Standard test (EU)

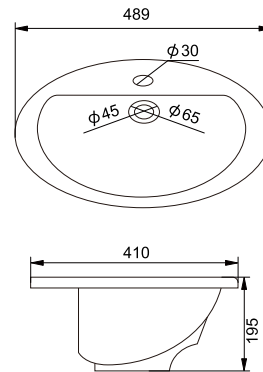

HM602(1)

檢測報告: J21965

Test Report

單孔鵝蛋半臺上式面盆

Semi recessed wash basin single hole

檢測標準 (歐盟): BS 1188: 1974 BS 3402:1969

Standard test (EU)

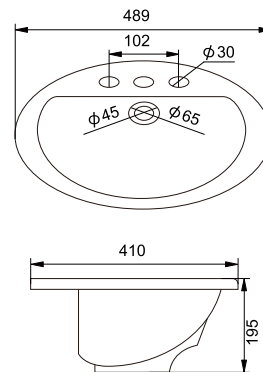

HM602(3)

檢測報告: J21965

Test Report

三孔鵝蛋半臺上式面盆

Semi recessed wash basin three holes

檢測標準 (歐盟): BS 1188: 1974 BS 3402:1969

Standard test (EU)



HM403

檢測報告: J17452-1r1

Test Report

白瓷低水箱

White porcelain low water tank

檢測標準 (歐盟): BS 3402:1969

Standard test (EU)

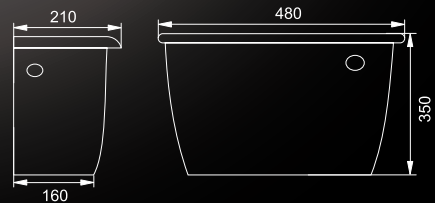

陶瓷產品系列出廠前都需完成各項測試。在密度方面，LEZA 產品高溫瓷表面更平滑細膩，瓷質高；在刮花測試方面，採用微分子釉面，具有更高密度釉面而損傷小。

The series of ceramic products need to be tested before they come out of the factory. In terms of density, the surface of LEZA high temperature porcelain is smoother and delicate, and the porcelain quality is high. In terms of scratching test, the micro molecular glaze has higher density glaze and less damage.

Stainless steel braided connectors

LEAH 軟管採用醫用的 304 不銹鋼鋼絲作為接頭，減少環境污染的產品。

LEAH hose uses medical 304 stainless steel wire as a joint to reduce environmental pollution.



技術參數 characteristics and technical specifications

Dn	外徑 Outer diameter	內徑 Outer diameter	內孔直徑 Outer diameter	3 巴壓力 下水流量 Flow rate	最小彎曲度 Minimum bending radius	最大工作壓力 Working pressure	最高工作溫度 Working temperature
6	10 mm	6 mm	4.6 mm	16 l/min at 3 bar	25 mm	10 bar	90 C
8	12 mm	8 mm	6 mm	28 l/min at 3 bar	30 mm	10 bar	90 C

材料 Material

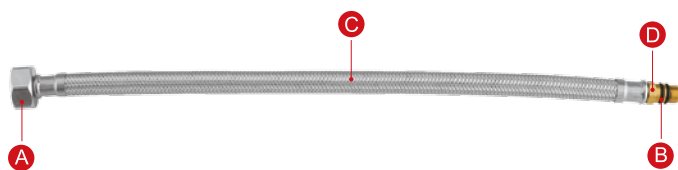

- A 不銹鋼 304 / SUS304 S.S
- B 三元乙丙橡膠 / Incorporated EPDM
- C 不銹鋼 304 / SUS304 S.S
- D 低鉛銅接頭 / Low lead and copper joint

